



ENGINEERED BY



SPIRATECH™ Series

AR-210

Midsized, High power and high directivity, 3 - way, Line array unit

Description :

The AR-210 enclosure is part of a Series of systems, which allows the assembly of different Line Arrays.

As with all the other components in this Series, it has been conceived to offer very high sonic performance, outstanding presence and extreme clarity, while meeting each and every one of the parameters that define the Line Array Technology.

The various elements found in the enclosure make use of sophisticated loudspeaker coupling techniques in order to implement the appropriate shading, thus permitting total control of the horizontal dispersion and avoiding the cancellations inherent to conventional P.A. Systems.

Furthermore, the use of complex wave-guides, permits an absolute control over the vertical coverage, an utmost necessity when directing our sonic energy to specific areas. The end result is a clear message without bouncing or reflected specific frequencies.

The necessary Vertical Coverage is obtained via the system's enclosures separation and angle setting between the same.

The full Line Array system will produce a coherent wave front which provides the interesting peculiarity of only losing 3dB every time we double the distance from the sound source. Conventional systems lose 6 dB in the same circumstances. This Line Array inherent advantage permits large SPL at long distances while offering bearable levels in the near field.

Another noticeable point is the easy set up procedure, thanks to our rugged and reliable flying assembly that permits a precise yet rapid installation.

Applications :

This powerful and highly modular system offers great directivity and flexibility. Therefore it can be used to sound small events up from one thousand listeners to medium concerts in open spaces. It meets the standards of the SLAS, (Scalable Line Array System), which adapts easily and can be used successfully in the most diverse tasks.

The system has been designed to cover medium to long distances, (Long Throw).

The minimum configuration consists of four AR-210, the full advantage of a Line Array rig is reached with eight units. Furthermore, the AR-210 offers full-range response, (52Hz - 18KHz), which permits, in many cases, its use without sub-woofers. When these are necessary, the Series' own ARS-215 will reproduce the frequencies as low as 40 Hz, filling-in that band of frequencies up to the 90 Hz mark.

The SpiraTech enclosures, conceived as fully operational Line Array devices, offer a series of specific characteristics:

- Continuous and coherent wave front
- Pattern Control
- Uniform SPL
- High resolution sound reproduction
- Configurable and predictable coverage
- Minimal signal process and settings

The recommended applications include:

- Auditoria
- Stadia
- Concert Halls
- Convention Centres
- Theatres
- Open-air concerts and general events
- Large Ballrooms



Specifications and characteristics

Frequency Response (Hz)	±3 dB (1 x AR210) 52Hz - 18kHz ±3 dB (8 x AR210) 45Hz - 18kHz
Horizontal coverage angle (-6dB)	110 deg. nominal (250Hz - 18kHz)
Vertical coverage angle (-6dB)	Variable, configuration dependant
Typical with 8 cabinets (0° Splay)	30 deg. nominal
Sensitivity 1 x AR210 (dB/2,83V@1m)	Low 100 dB - Mid 103 dB - High 112 dB
Sensitivity 8 x AR210 (dB/2,83V@1m)	Low 111 dB - Mid 116 dB - High 123 dB
SPL Max / Peak (dB SPL@1m)	1 x AR210 131 dB - 137 dB 8 x AR210 152 dB - 155 dB
Recommended signal processor	RAM Audio LMS 244 Digital Processor

Constructive elements

Low frequency	2 x 10" transducers with 3" coil 600W AES (.300W AES per unit)
Mid frequency	2 x 6.5" transducers with 2" coil Neodymium magnet, 400W AES (200W AES per unit)
High frequency	1 x Compression driver, 2" throat, 4" coil Titanium membrane, Neodymium magnet 90W AES

Enclosure & suspension Hardware

Enclosure	Horizontal parallelepiped construction 18mm Baltic cross ply, tongue and groove assembly throughout. 30mm front panel and outer frame. Bi-component epoxy finish
Protection grill	1.5mm laminated steel with textured epoxy finish
Enclosure protections	Skids on all resting surfaces
Handles	Cut in the enclosure for ease of handling
Connectors	Two Neutrik NL8 connectors on steel back plate
Dimensions (H x W x D)	1055 x 451 x 273 mm (41.5 x 17.7 x 10.7 inches)
Net weight	43 Kg (94.6 Pounds) including inserted rigging system
Rigging system	Self-contained, integrated Rigging system with no protruding or loose parts for ease of transport and assembly. Designed to rig and fly up to 20 enclosures with a 1:5 design factor.

AR-210 Midsize, High power & high directivity, 3-way, line array unit

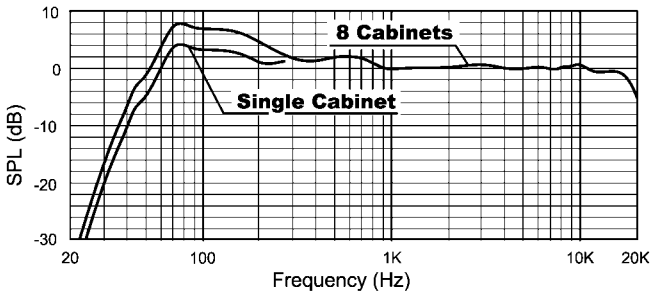

Global normalized response

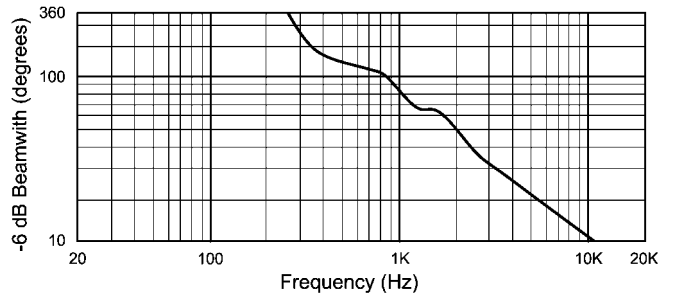

Vertical coverage (Single cabinet)

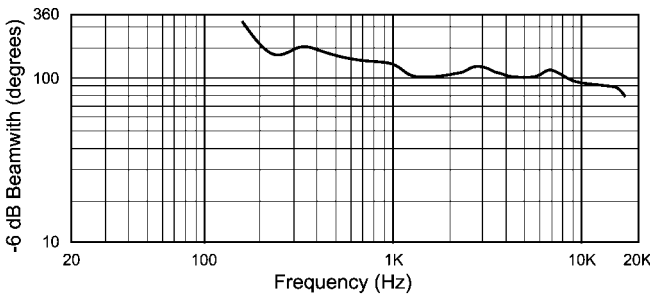

Horizontal coverage (Typical array)

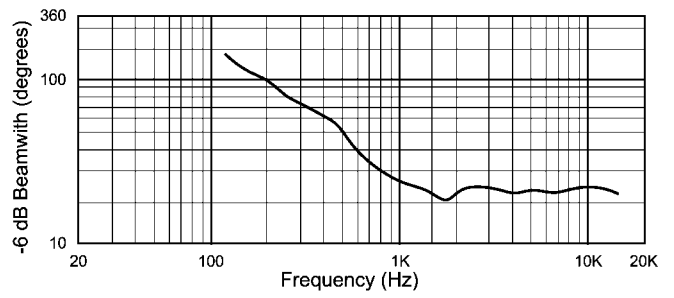

Vertical coverage (Two cabinets @ 10°)

Acoustic response measuring system

The Acoustic Measures of this Line Array Unit have been made taking into account its use context, this is as an individual cabinet to be part of a Line Array Assembly.

The measure of Frequency Response is that of a single AR-210 enclosure with our recommended, and in the case of our RAM Audio LMS 244, preset, controller settings for crossover, levels and EQ as defined in our accompanying software.

The Vertical Coverage shown in the graphs, from one to eight AR-210, corresponds to a given system with a Splay angle of 10 degrees between adjacent enclosures, except for the one specified at 0 degree which corresponds to a Vertical Line Array with 0 degree Splay angle.

All measures have been taken according to the Gathered Technique with a calibrated microphone centred on the enclosure or Array axis. The polar pattern data are taken symmetrically with respect to the reference axis, at 5 degree intervals, from 0 to 355°, using an LMS digital measuring system.

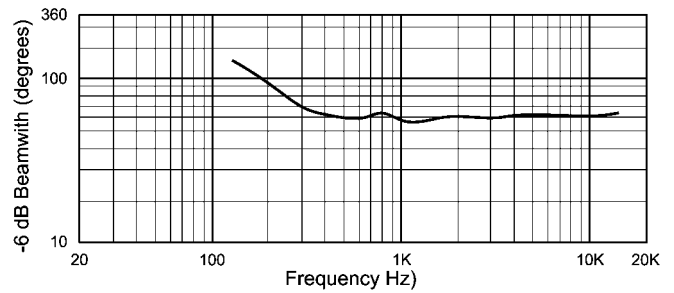

Vertical coverage (Four cabinets @ 10°)

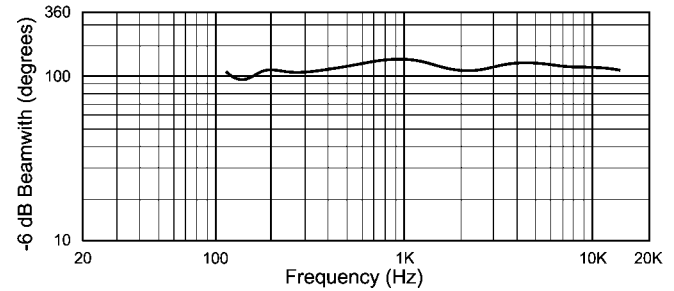

Vertical coverage (Eight cabinets @ 10°)

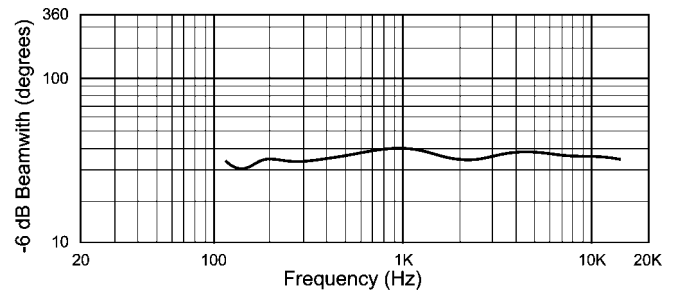

Vertical coverage (Eight cabinets @ 0°)

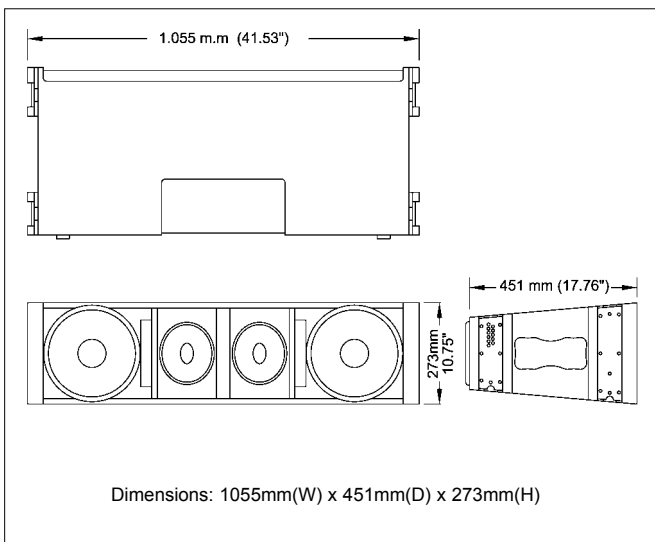

AR-210

Midsized, High power & high directivity, 3-way, line array unit

SPIRATECH™ ARRAYS

The configurable Arrays obtained with the AR-210 are scalable systems, (SLAS), easily and rapidly adapted to any particular need. They follow the theory of the spiral Line Arrays. The enclosures have to be flown vertically and oriented according to the coverage required and always as a multi-enclosure system.

The 120° Horizontal coverage is constantly maintained, regardless of the Splay between the units and their amount, directly proportional to the Vertical Coverage required.

The Vertical Coverage needed, as well as the SPL, are obtained through preset Splay angulations, while the array is assembled on the ground and depend on the number of AR-210 enclosures used.

Our very user friendly flying fixtures permit choosing the Splay angles between 0 and 10 degrees according to the simulation program.

Up to twenty AR-210 can be flown from the supporting frame TF-210.

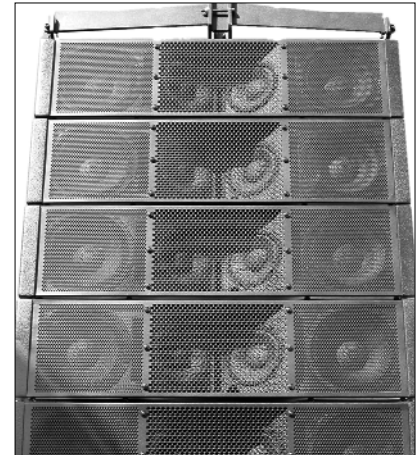

TF-210 Assembly Top Frame

Designed to support up to twenty AR-210, the frame is made of laser cut steel, with an epoxy finish. It lifts the suspended Line Array from one or two anchoring points. The back transversal bar receives the slings to rigidify the Array with the use of the Bottom Frame.



IFF-210 Interface Frame

(Permits assembling AR-210 with AR-215)

This attachment permits joining together several units of the two systems for the use of the AR-210 as front-fill units.

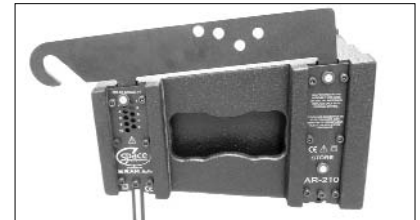

FC-210 Assembly Frames, Transport Flight-case

This rigid, ergonomic and practical transport flight-case accepts two double sets of top. All inner surfaces are lined with high-density polyurethane foam and divided so that every element is individually protected.



FCC-210 Transport Flight-case for three AR-210

This specific, rigid, ergonomic and practical transport flight-case accepts three AR-210 cabinets. All inner surfaces are lined with high-density polyurethane foam.



C.E. STUDIO 2 S.L.
P.I. La Lloma, c/ Sierra Perenchiza 28
46960 Aldaya - Valencia - Spain
Phone: +34 96 1273054
Fax: +34 96 1273056
<http://www.spaceequipmentaudio.com>
e-mail: support@spaceequipmentaudio.com